

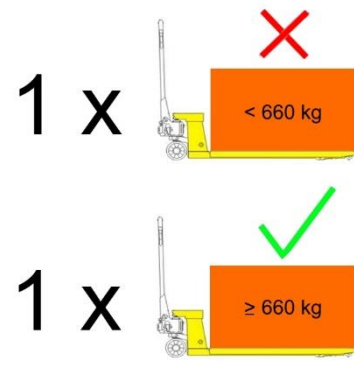

I • Maschine aufstellen

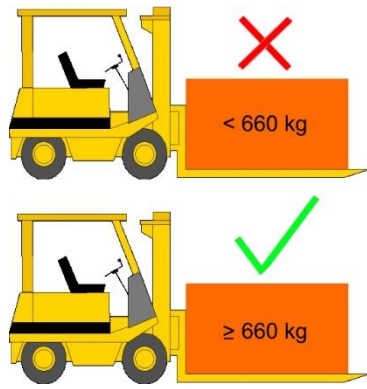

II • Bedienung



- 1) Hauptschalter
- 2) Band-Schnellspanner
- 3) Transportband
- 4) Stoptaster
- 5) Starttaster
- 6) Verschluss Messerschutzkasten
- 7) Verschluss Haube Transportband
- 8) Haube Transportband
- 9) Haube Beschickung
- 10) Klapptisch
- 11) Rastbolzen
- 12) Wanne Beschickung
- 13) Seitendeckel
- 14) Maschinenfuß
- 15) Messerschutzkasten
- 16) Zuleitung
- 17) Typenschild
- 18) Abschneidemesser
- 19) Messerbalken
- 20) Vertikalmesser



III • Bedienelemente



IV • Sicherheitsfunktionen



V • Klapptisch

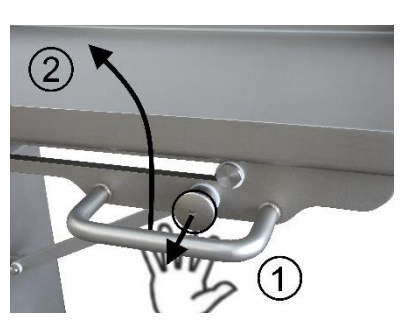

VI • Erstinbetriebnahme

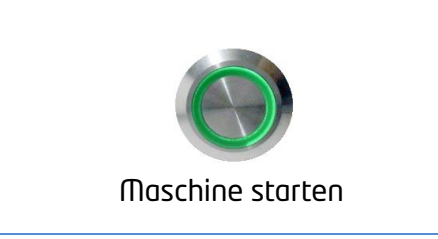
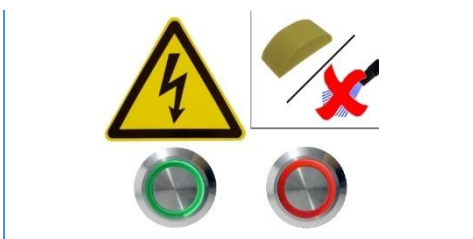
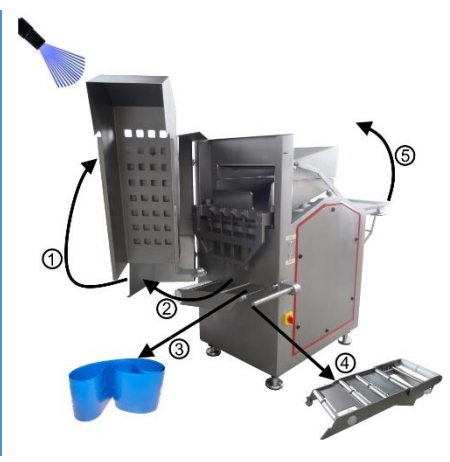

VII • Maschine einrichten



VII • Einrichten



VIII • Normwagen



IX • Klapptisch (füllen)



X • Wanne (füllen)



XI • Start



XII • Bedienung

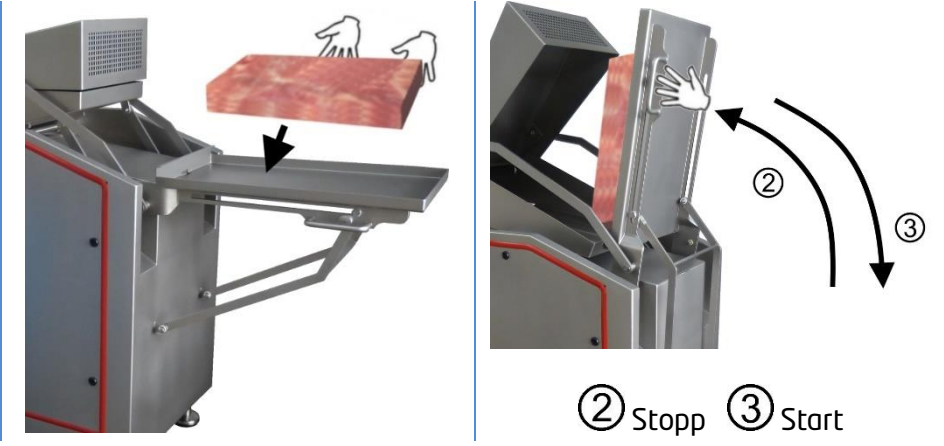

XIII • Stopp

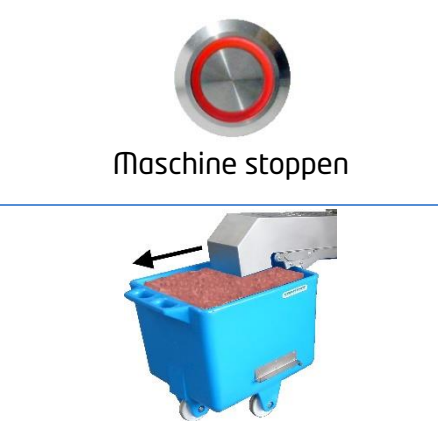

XIV • Reinigung (Vorbereitung)

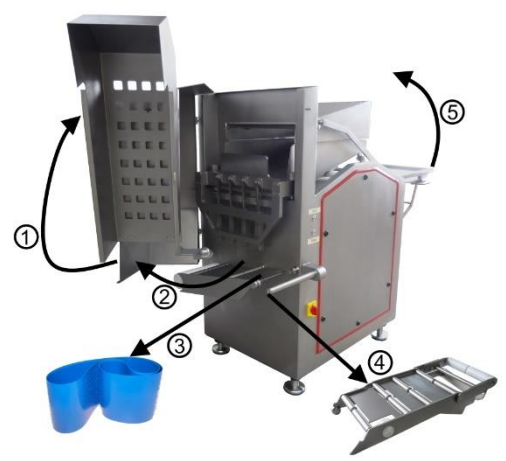
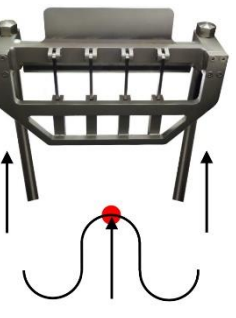

XV • Reinigung

