

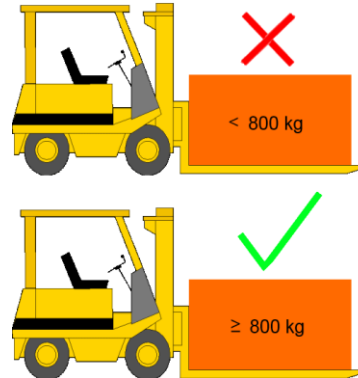

I • Maschine aufstellen

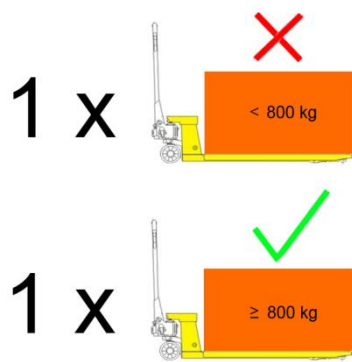

II • Bedienung

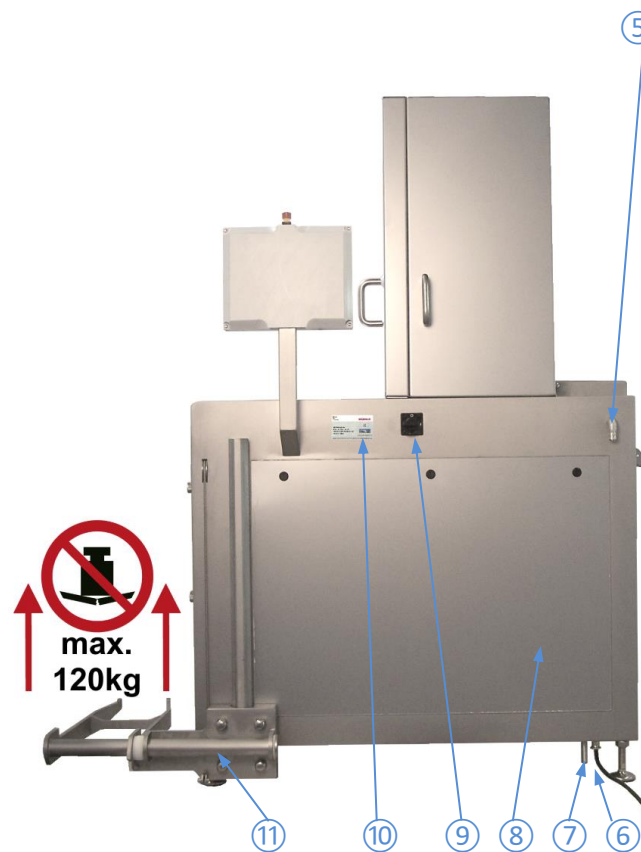

- 1) Haube
- 2) Not-Halt Taster
- 3) Bedienfeld
- 4) Beschickungsgabel
- 5) Wasseranschluss
- 6) Zuleitung
- 7) Zuleitungsschutz
- 8) Seitendeckel
- 9) Hauptschalter
- 10) Typenschild
- 11) Hebehilfe
- 12) Laketür
- 13) Taster Hebehilfe
- 14) Lakemischer / Ansaugung
- 15) Ultraschallsensor
- 16) Eingreiftschutz (Auslauf)
- 17) Eingreiftschutz (Einlauf)

⑤ • Wasseranschluss

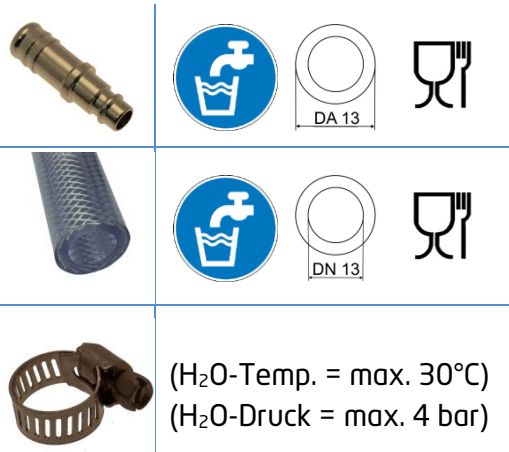

② • Not-Halt

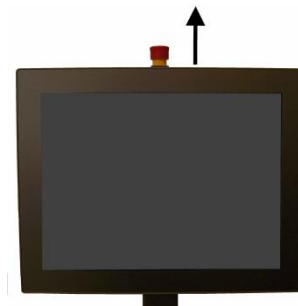

⑨ • Hauptschalter

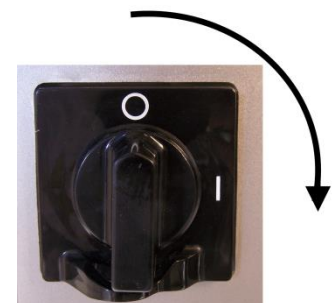

III • Innenreinigung

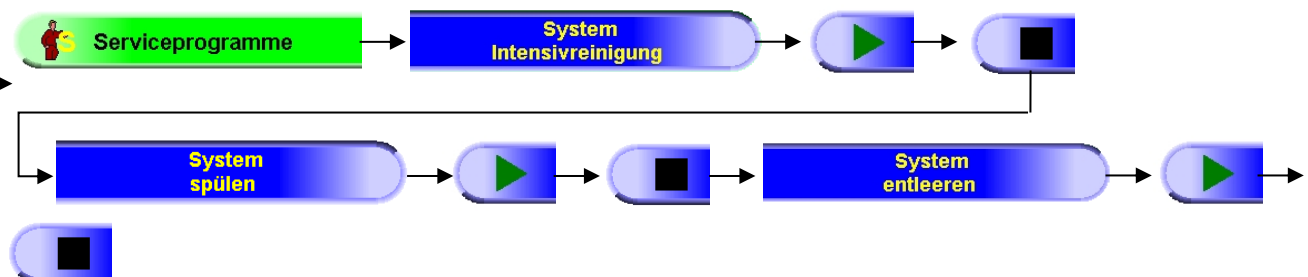

IV • Außenreinigung

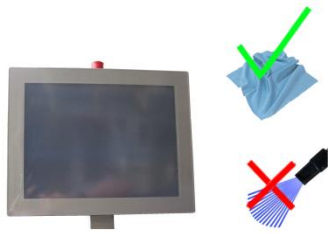

V • Rezeptauswahl / Rezeptstart

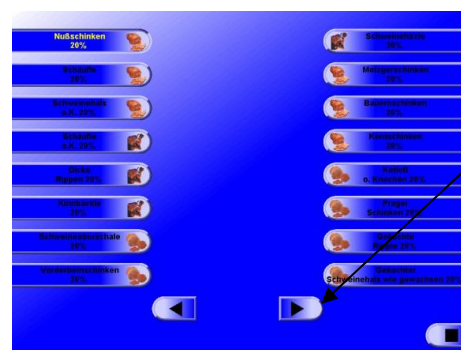

Rezept / Rezeptname
 Taster zum Durchblättern der Rezepte
 Zurück
 Rezeptstart
 Rezept-editor
 Statistik

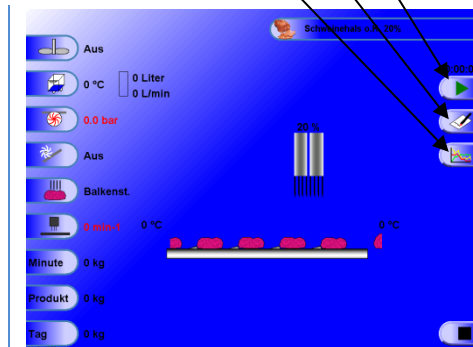
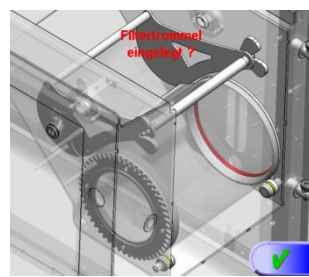
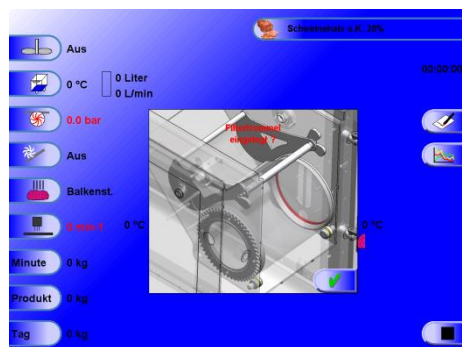
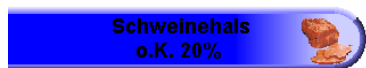

V • Programmierung Rezept

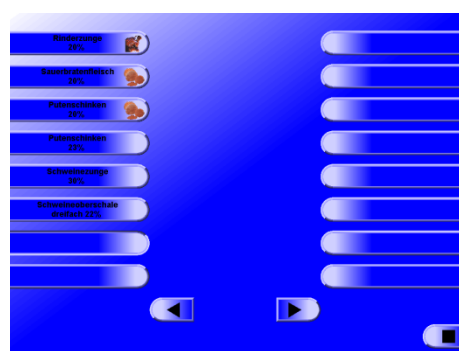
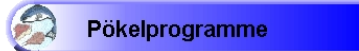

Änderung von Rezepten



Neuanlage von Rezepten

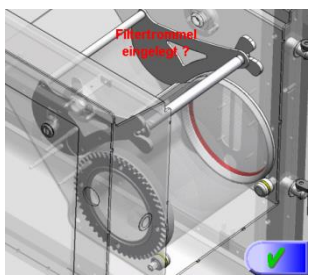

Rezepteditor



Werkseinstellung
 Passwort = „0“

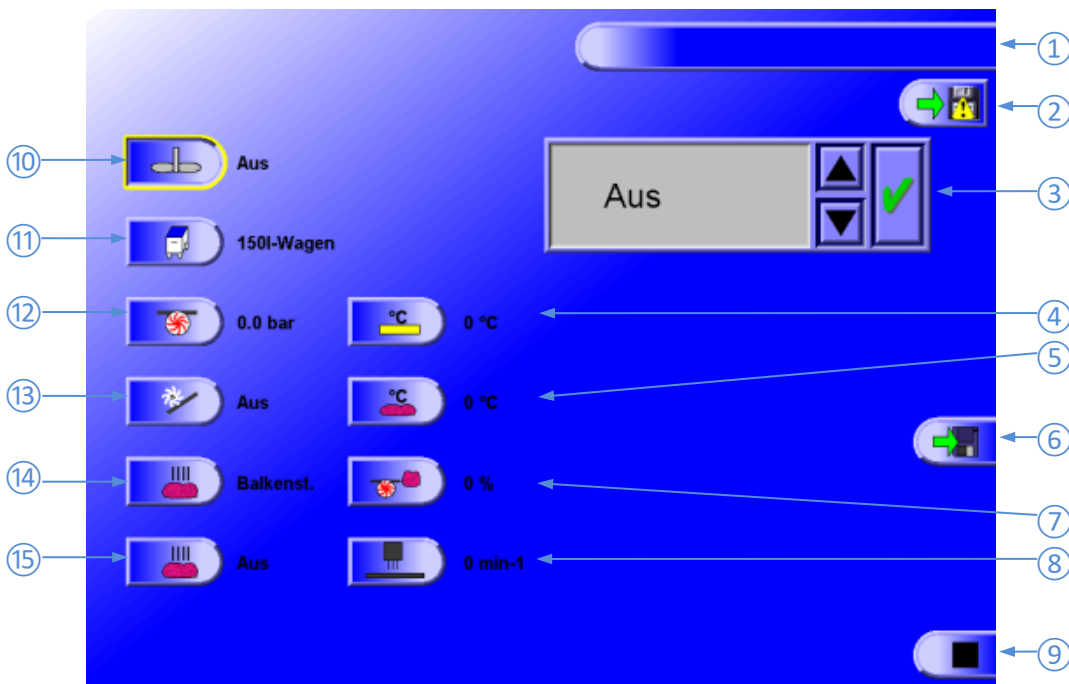

- 1) Rezeptname (leer für Neuanlage)
- 2) Backup
- 3) Auswahlfenster / Auswahlbestätigung
- 4) Laketemperatur
- 5) Fleishtemperatur
- 6) Speichern

- 7) Injektionsmenge in %
- 8) Einstichhäufigkeit / Minute
- 9) Zurück
- 10) Lakemischer
- 11) Lakebehälterart
- 12) Einspritzdruck
- 13) Lakeaufbereitung
- 14) Einspritzsystem
- 15) Softereinsatz