

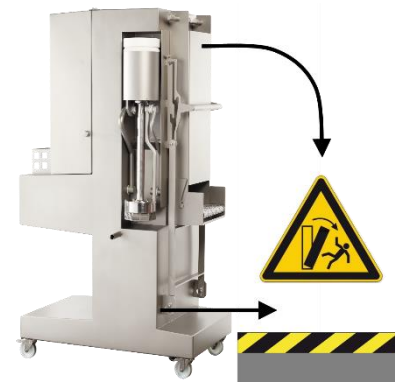

I • Maschine aufstellen

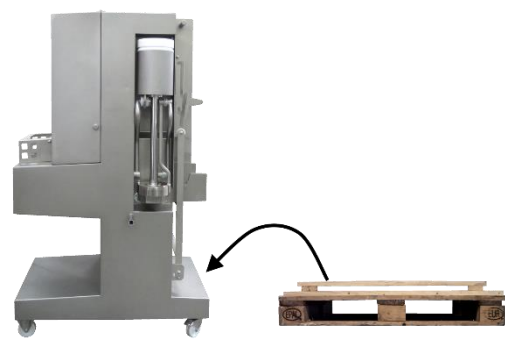

II • Bedienung

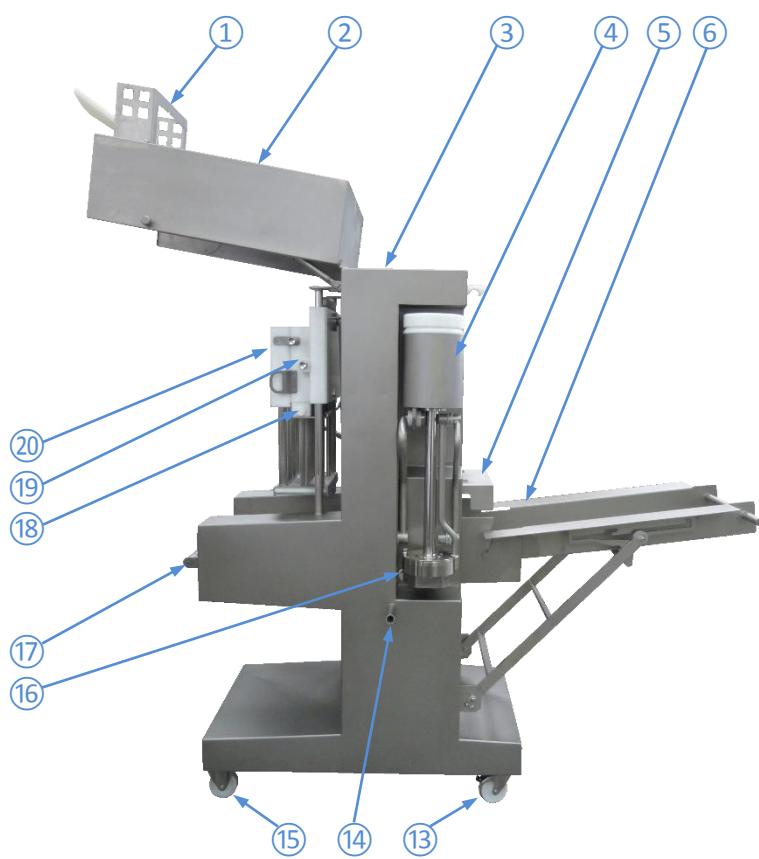

- 1) Eingreiftschutz Auslauf
- 2) Pökelraumtür
- 3) Gestell
- 4) Kreispumpe
- 5) Eingreiftschutz Einlauf
- 6) Beschickungsrampe
- 7) Schalter
- 8) Bedienfeld (Mini-IPC)
- 9) Hauptschalter
- 10) Reinigungsplatte
- 11) Filter
- 12) Typenschild
- 13) Lenkrolle mit Bremse
- 14) Lakerücklaufrohr
- 15) Lenkrolle ohne Bremse
- 16) Lakeremischer
- 17) Transportband
- 18) Nadelregister
- 19) Federmagazin
- 20) Softer

III • Rezeptstart / Rezeptauswahl

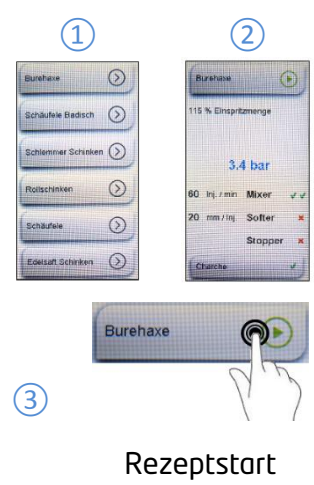

- 1) Rezeptstart (1 Sek. drücken)
- 2) Rezeptname ändern (2 Sek. drücken)
- 3) Info-Text einsehen (1 Sek. drücken)
- 4) Info-Text eingeben (2 Sek. drücken)
- 5) Einspritzdruck (2 Sek. drücken)
- 6) Hub pro Min. (2 Sek. drücken)
- 7) Mixer-Einstellung (2 Sek. drücken)
- 8) Vorschub pro Hub (2 Sek. drücken)
- 9) Softer-Einstellung (2 Sek. drücken)
- 10) Stopper-Einstellung (2 Sek. drücken)
- 11) Chargen-Text eingeben (1 Sek. drücken)
- 12) Chargen-Einstellung (2 Sek. drücken)

IV • Programmierung Rezept

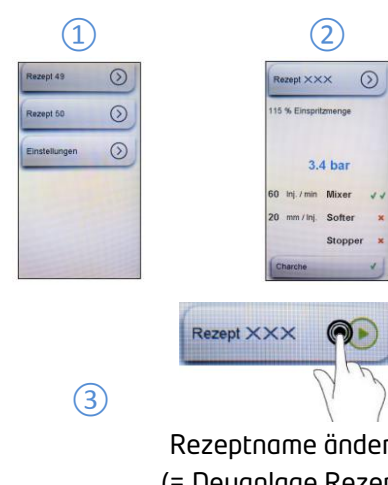

Rezeptname ändern (= Neuanlage Rezept)

V • Neuanlage Rezept

VI • Beschickungsrampe

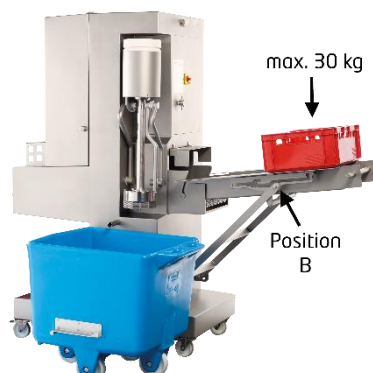
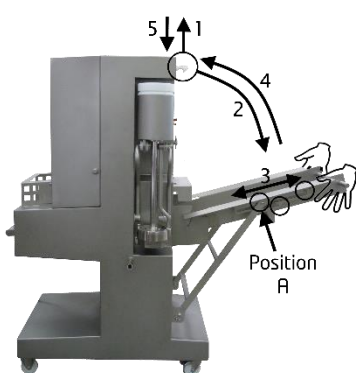

VII • Kreispumpe



16 • Lakemischer



	Stop
	Soft Mix
	Hard Mix

20 • Softer Ein- u. Ausbau 1 • Eingreifschutz 5 • Eingreifschutz 2 • Pökelraumtür

Einbau:

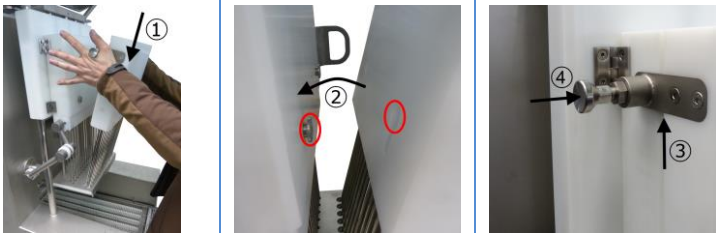

Ausbau:

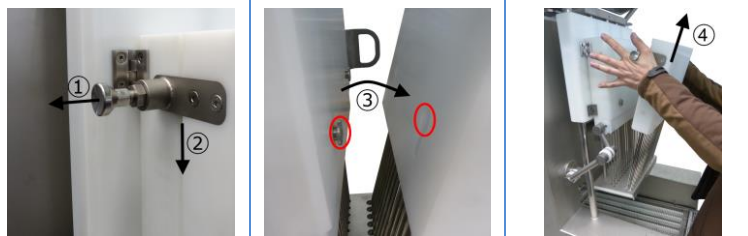

18 • Nadelwechsel VI • Nadelbalken

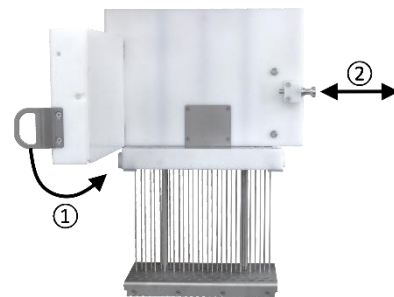
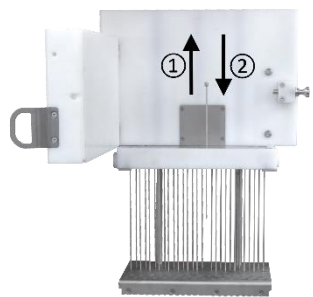
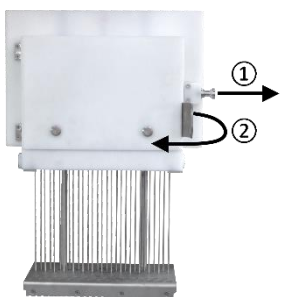

17 • Transportband VII • Bandentnahme

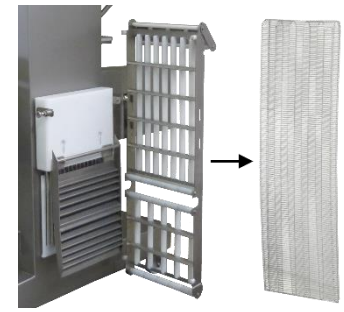
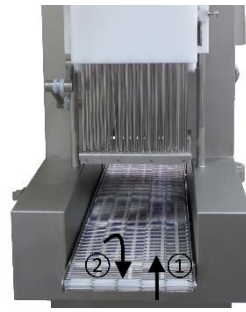
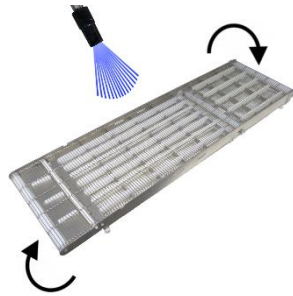

11 • Filter VIII • Werkzeugmagazin

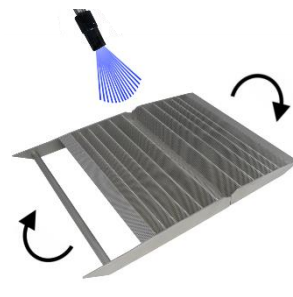
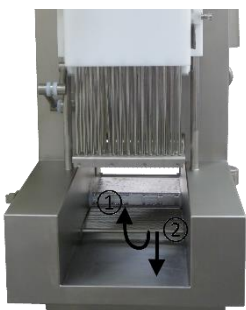

IX • Reinigung

