

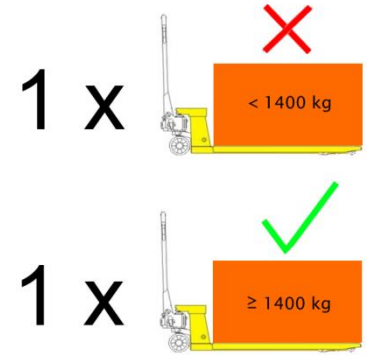

I • Installing the machine

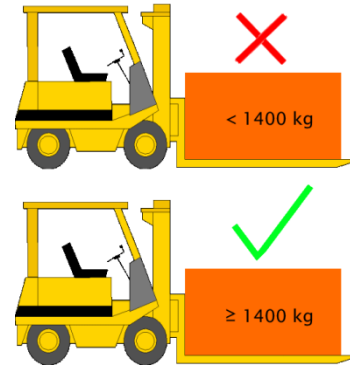

II • Operation

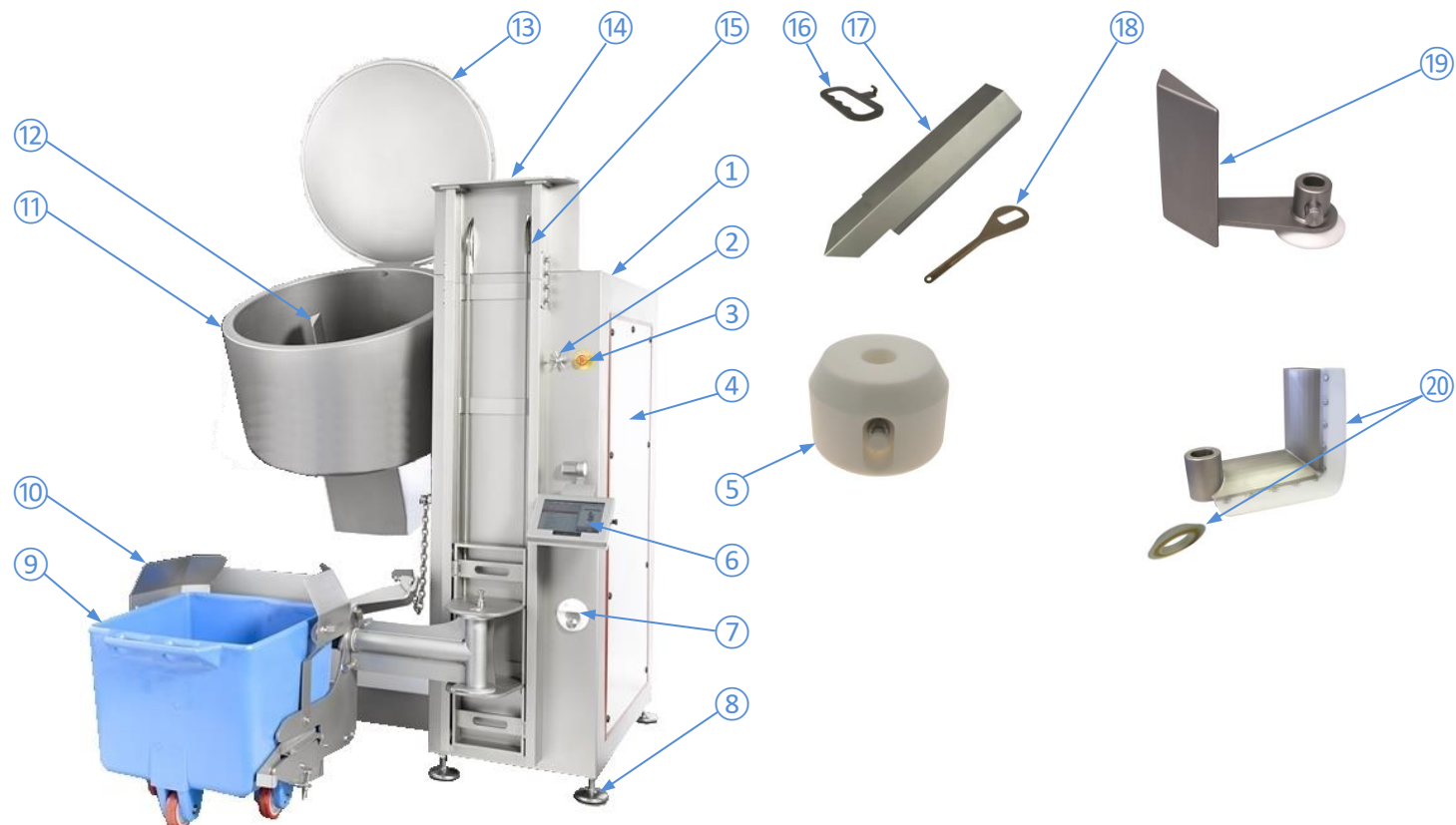

- 1) Frame
- 2) Control wheel
- 3) Emergency stop button
- 4) Side panel
- 5) Plug for work without mixing arm
- 6) Operation panel (Tablet-PC)
- 7) Condensation flap
- 8) Machine foot
- 9) Trolley (optional)
- 10) Trolley reception
- 11) Drum
- 12) Tumbling system
- 13) Lid
- 14) Bail wire rope
- 15) Lift system
- 16) Mounting aid scraper
- 17) Discharging aid (Trolley connection)
- 18) Installation wrench trolley reception
Mixing arm
- 19) Tumbling arm

▶ • Recipe selection / Recipe start

The app interface consists of several screens:

- (Welcome screen):** Shows a list of recipe categories such as '1 Tumbeln', '2 Kochsalzprodukte', '3 Rohschinken Salzen', etc.
- (Recipe selection):** A tree view showing 'Recipe group' and 'Recipe name' options.
- (Recipe):** A detailed view of a selected recipe with a list of steps and their durations, such as '1 Verarbeitungsfleisch 5 min', '2 Brät entlüften', etc.
- (Manual settings):** A control screen for manual operation with sliders for 'Lifting aid', 'Tumbling arm', 'Mixing arm', 'Temperature', 'Vacuum', 'Drum', and 'Lid'. It includes 'Start' and 'Edit' buttons.

• Programming / Programming recipes

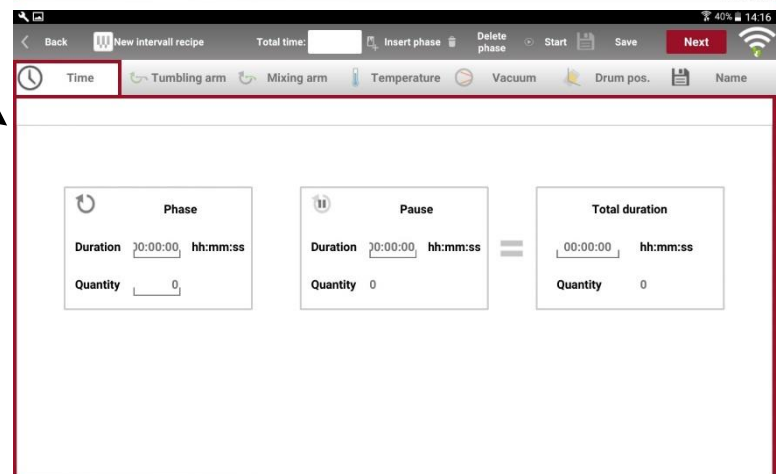
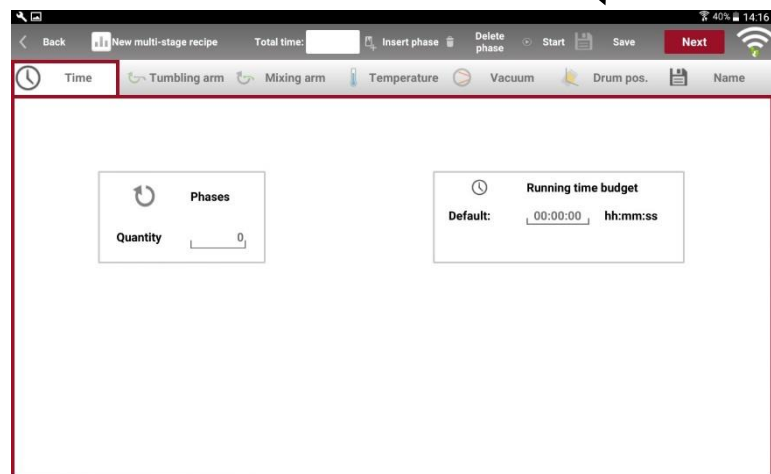
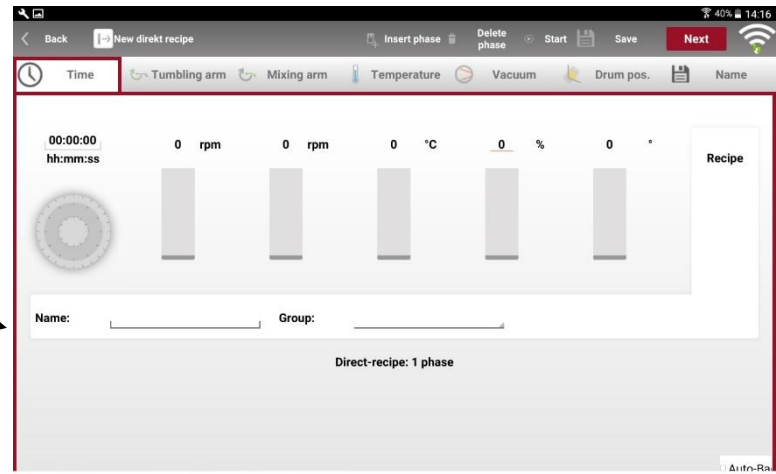
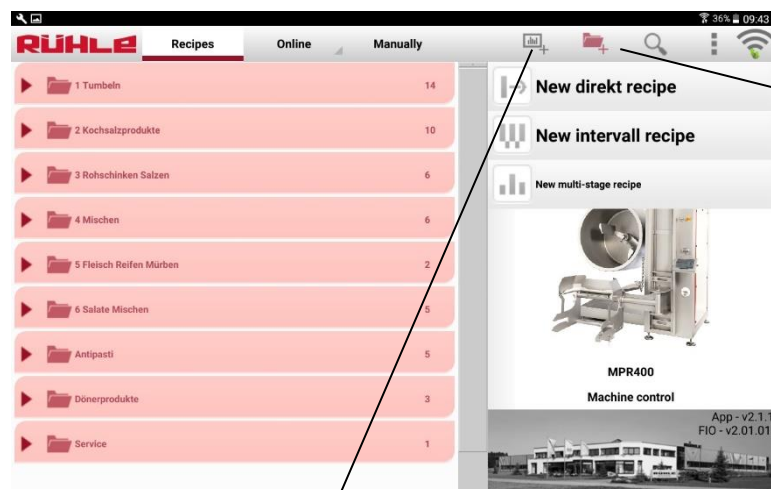

✳ • Control wheel - Manual operation

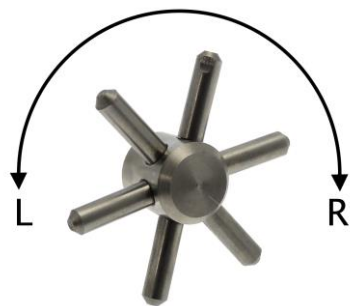

Limit stop left	Limit stop right
Lid close	Lid open
Swing drum down	Swing drum up
Lifting aid downwards	Lifting aid upwards
Tumbling system counterclockwise	Tumbling system clockwise
Simultaneous movement of drum and arm (discharging)	Simultaneous movement of drum and arm (discharging)

III • Manual settings

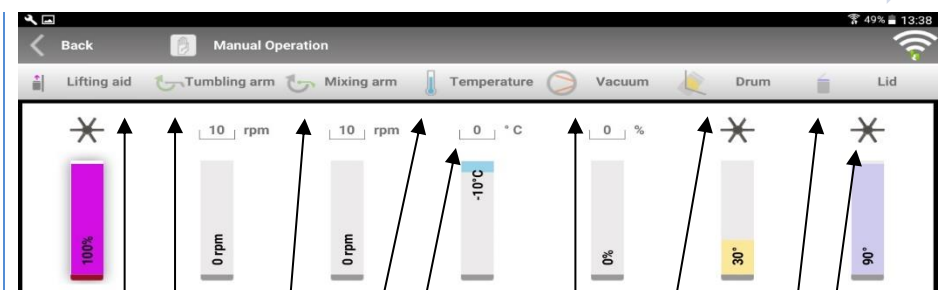

- Lifting aid
- Tumbling arm (0 rpm to 25 rpm)
- Mixing arm (0 rpm to 25 rpm)
- Temperature (-25°C to +30°C)
- Input boxes
- Vacuum (0% to 90%)
- Drum (30° to 102°)
- Lid (0° to 100°)
- Icon for manual control

III • Cleaning

